

In-car portion finished in grey hammered enamel

LIGHTING

SWITCHES

IGNITION

WIRING

HEATERS,
ELECTRIC
FANS

FUEL AIR

GAUGES

WASHERS
WIPERS

MIRRORS

SEATS, SEAT
BELTS

STEERING
WHEELS

MOTORCYCLE
PARTS

ACCESSORIES

BODY
HARDWARE

CAR CARE
PAINT

OIL, GREASE

FITTINGS

WHEELS,
BRAKES

TOOLS

COMPETITION

CLOTHING

GIFTS

BOOKS



SANDWICH TYPE HEATER/BLOWER

- 12V operation, heat output 4kw.
- This heater can either be used as a recirculating type, or it can be split so that the element is on the engine side of the bulkhead and the fan box is inside the car.
- Two outlets for demisting (uses 13/4" dia. plastic hose).
- One door to control heat into the car.
- Supplied complete with 3 metres of water hose and clips, 2 metres of demist hose and wire clips, 2 metres of cable and 3 position switch.
- Fitted to Morgans and similar cars.

SD/080.511

£444.96 each | £370.80 ex VAT

It is possible to change the configuration of the side panels by using the options below:



Single Demist Outlet

SD/080.551

£9.46 each | £7.88 ex VAT



COMPACT HEATER

Have nice warm feet! Easy to install 4kw Heater, 275mm wide, 115mm tall and 200mm deep. 12 volt operation with two 13mm diameter stubs to connect to your engine cooling system. (No provision for demisting)

SD/080.512

£182.40 each | £152.00 ex VAT



COMPACT HEATER

A compact 4kw Heater. 252mm wide, 115mm tall and 256mm deep. 12 volt operation with two 16mm (5/8") diameter stubs to connect to your engine cooling system. Two adjustable outlets and two 32mm (1 1/4") demist outlets

SD/080.513

£238.80 each | £199.00 ex VAT

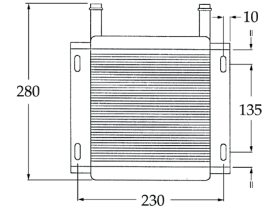
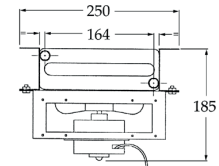

SPARES FOR CLAYTON HEATERS



FAN MOTOR SINGLE SHAFT

With 1/4" shaft at one end. Can be connected to run in either direction

080.514

£67.20 each | £56.00 ex VAT



FAN MOTOR DOUBLE SHAFT

With 1/4" shaft at both ends. Can be connected to run in either direction

080.545

£74.40 each | £62.00 ex VAT



3 BLADE FAN

(Left) Plastic fan secured by grub screw onto a 1/4" shaft, 172mm (6.75") diameter

080.555

£9.54 each | £7.95 ex VAT



4 BLADE FAN

(Right) Aluminium fan secured by grub screw onto a 1/4" shaft, 152mm (6") diameter

080.554

£17.94 each | £14.95 ex VAT

HEATERS UPGRADES BY CLAYTON



HEATER UPGRADES

(Left above) For **MGB** 1962-80. With a modern 3-speed motor and centrifugal fan and more modern/larger element. The box is the same shape as the original, with 'SMITHS' stamped into the cover, but slightly thicker front to back at 135mm to contain the uprated components

080.489 £376.74 each | £313.95 ex VAT

(Right above) For **Jaguar XK120/140** Roadster. An upgraded heater box giving a considerable increase in performance over the original

080.792 £351.54 each | £292.95 ex VAT



HEATER UPGRADE KIT FOR JAGUAR MK II

An upgraded and simplified heater giving a considerable increase in performance over the original. Includes new heater core, fan motor, fan and fittings

080.791
£344.84 each | £287.37 ex VAT



HEATER UPGRADE KIT FOR JAGUAR E TYPE SERIES 1 & 2

An upgraded heater giving a considerable increase in performance over the original. Includes new heater matrix, fan motor and fan

080.794
£199.25 each | £166.04 ex VAT



HEATER UPGRADE KIT FOR JAGUAR E TYPE SERIES 3 (V12)

An upgraded heater giving a considerable increase in performance over the original. Includes new heater matrix and fan motor

080.795
£204.60 each | £170.50 ex VAT



HEATER UPGRADE KIT - JAGUAR XK150 (LATE-UNDER BONNET HEATER)

An upgraded heater giving a considerable increase in performance over the original

080.793
£199.96 each | £166.63 ex VAT

UPRATING CLAYTON HEATERS



CLAYTON FAN MOTOR SINGLE 5/16 IN SHAFT TO UPRATE YOUR HEATER

(Above) Powerful 12 volt Fan Motor with $\frac{5}{16}$ in shaft. A nice motor with cast end plates which can be wired up to rotate in either direction. Can be used to uprate the heater on the Jaguar Mk II. Use with Mounting Plate 080.547, Baffle 080.548 and Fan 080.558

080.546
£79.20 each | £66.00 ex VAT



MOUNTING PLATE FOR MOTOR 080.546

(Above) Use with Motor 080.546, Baffle 080.548 and Fan 080.558 on **Jaguar Mk II**. Coated steel

080.547
£15.00 each | £12.50 ex VAT



METAL FANS

Metal Fan with the vanes arranged for anti-clockwise rotation. Maximum diameter 120mm, width 64mm, bore for motor shaft $\frac{5}{16}$ in. This can be used with parts 080.546, 080.547 and 080.548 to upgrade the heater on the **Jaguar Mk II**. (Anti-clockwise when viewed from the 'open' end)

080.558
£22.90 each | £19.08 ex VAT

LIGHTING
SWITCHES
IGNITION
WIRING

**HEATERS,
ELECTRIC
FANS**

FUEL AIR
GAUGES
WASHERS
WIPERS
MIRRORS

SEATS, SEAT
BELTS
STEERING
WHEELS

MOTORCYCLE
PARTS
ACCESSORIES

BODY
HARDWARE

CAR CARE
PAINT

OIL, GREASE

FITTINGS

WHEELS,
BRAKES

TOOLS

COMPETITION

CLOTHING

GIFTS

BOOKS

HEATERS FOR SPECIFIC CARS



HEATER/BLOWER FOR MGB 1962-72
Original style Heater/Blower for MGB 1962-72 as shown in the picture

080.234
£311.04 each | £259.20 ex VAT



HEATER FOR MIDGET/SPRITE 1958-72
Box is 255 mm deep x 240 mm tall x 87 mm wide. Outlet is 3 3/4" (83 mm) diameter. The box has SMITHS on its side

080.233
£280.80 each | £234.00 ex VAT

LIGHTING

SWITCHES

IGNITION

WIRING

**HEATERS,
ELECTRIC
FANS**

FUEL AIR

GAUGES

WASHERS

WIPERS

MIRRORS

SEATS, SEAT

BELTS

STEERING

WHEELS

MOTORCYCLE

PARTS

ACCESSORIES

BODY

HARDWARE

CAR CARE

PAINT

OIL, GREASE

FITTINGS

WHEELS,
BRAKES

TOOLS

COMPETITION

CLOTHING

GIFTS

BOOKS

HEATER ACCESSORIES



CABLE OPERATED WATER VALVE - PULL FOR OFF

For use with 5/8" internal diameter pipe. Pull for OFF. For a cable to operate this valve refer below

080.530
£37.01 each | £30.84 ex VAT



CABLE OPERATED WATER VALVE - PUSH FOR OFF

For use with 5/8" internal diameter pipe. Pull for ON, push for OFF. For a cable to operate this valve refer below

080.626
£65.09 each | £54.24 ex VAT



CABLE OPERATED WATER VALVE

As fitted to the A series engines in A40 Farina type and later to early Classic Minis. This is the straight type that will fit all 1275cc A series and most 998cc engines. Original Equipment Part No was 13H5506

080.627
£22.80 each | £19.00 ex VAT



WATER VALVE CABLE
1600mm long cable with a loop at either end

080.549
£19.80 each | £16.50 ex VAT



WATER VALVE CABLE
If you need a method of operating this valve remotely, we offer a cable with a knob which can be adapted, 1600mm long

015.384
£8.64 each | £7.20 ex VAT



DATA PLATE
For Smiths heaters. 90mm x 20mm. You will need to stamp on a code, model and voltage

080.243 £5.88 each | £4.90 ex VAT

RADIATOR EXTRAS



RADIATOR DRAIN
(Left) A very neat radiator drain valve. 3/8" X 27 NPTF

080.820
£10.04 each | £8.37 ex VAT

ANTI-FREEZE TESTER
(Right) Measures degree of protection

091.042
£8.74 each | £7.28 ex VAT





JAGUAR MK 2
080.475

HEATER ELEMENTS				
New heater elements made by the original manufacturer				
<i>Make & Model</i>	<i>Details</i>	<i>Part No.</i>	<i>Price each</i>	<i>Ex VAT</i>
Jaguar Mk 2	Made to the original specification	080.475	£96.00	£80.00

LIGHTING
SWITCHES
IGNITION
WIRING

**HEATERS,
ELECTRIC
FANS**

FUEL AIR
GAUGES
WASHERS
WIPERS
MIRRORS
SEATS, SEAT
BELTS
STEERING
WHEELS
MOTORCYCLE
PARTS
ACCESSORIES
BODY
HARDWARE
CAR CARE
PAINT
OIL, GREASE
FITTINGS
WHEELS,
BRAKES
TOOLS
COMPETITION
CLOTHING
GIFTS
BOOKS

CIRCULAR HEATER

+44(0) 1885 488 488

- LIGHTING
- SWITCHES
- IGNITION
- WIRING
- HEATERS, ELECTRIC FANS**
- FUEL AIR
- GAUGES
- WASHERS WIPERS
- MIRRORS
- SEATS, SEAT BELTS
- STEERING WHEELS
- MOTORCYCLE PARTS
- ACCESSORIES
- BODY HARDWARE
- CAR CARE PAINT
- OIL, GREASE
- FITTINGS
- WHEELS, BRAKES
- TOOLS
- COMPETITION
- CLOTHING
- GIFTS
- BOOKS



CIRCULAR HEATER

- 12V operation
- Heat output 2kw
- With or without a demist facility
- Water pipes straight or bent at 90°
- You can reassemble them with the pipes anywhere around the circle
- Two doors to control heat into the car
- Nice period appearance
- Finished in grey hammered enamel
- Overall diameter 210mm
- Demister outlets use 1 1/4" dia hose
- This is probably the easiest type of heater to fit if your car never had a heater
- Ideal for kit cars

With straight pipes and no demist facility

080.500 £381.83 each | £318.19 ex VAT

With straight pipes and demist facility

080.501 £417.95 each | £348.29 ex VAT

With bent pipes and no demist facility

080.502 £381.83 each | £318.19 ex VAT

With bent pipes and demist facility (drawing right)

080.503 £417.96 each | £348.30 ex VAT

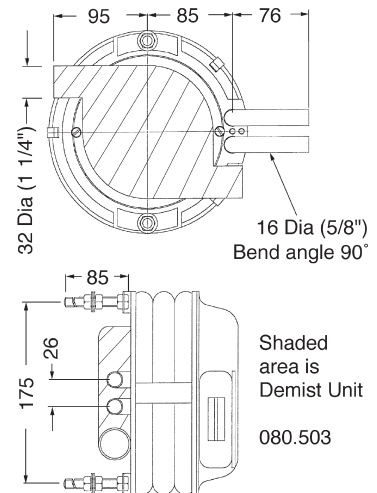

REPLACEMENTS FOR SMITHS' CIRCULAR HEATER ELEMENTS

The elements originally made by Smiths were of three depths, 2 1/4", 3" and 4". The replacement elements made by CLAYTON are 2 7/8" in depth but come with three new clips which enable you to reassemble your heater with the new element (there is one exception to this, a 4" deep element, made to special order, for early Austin Healeys). A small adjustment to the fan position on the motor shaft may be required. The copper construction and improved water flow through the new element produces a substantial heat output and it will not corrode like the original steel unit

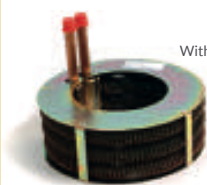

Without motor plate

Available with or without motor plate:
Without motor plate

SD/080.505
£239.29 each | £199.41 ex VAT



With motor plate

With motor plate
SD/080.506
£239.29 each | £199.41 ex VAT



A special is available for Bentley & Rolls-Royce cars
SD/080.507
£239.29 each | £199.41 ex VAT



A special is available for Austin Healey 100 & 100-SIX cars
080.508
£326.30 each | £271.92 ex VAT



A special is available for Jaguar XK120/XK140/XK150 cars
080.509
£295.92 each | £246.60 ex VAT

There were many other configurations and if you think yours is special please supply a drawing with at least the following dimensions: Diameter, depth, position, and length of pipes, details of motor mounting plate (if integrated with the element). Please supply drawing with your order

080.504
Price on Application

For your radiator and heater requirements. Hand crafted from black silicone



**RADIATOR HOSE KIT
JAGUAR E TYPE 3.8 1961-64**
Eleven hoses
081.345
£199.94 each | £166.62 ex VAT



**RADIATOR HOSE KIT
JAGUAR E TYPE 4.2 SERIES 1**
Thirteen hoses
081.346
£219.30 each | £182.75 ex VAT



**RADIATOR HOSE KIT
JAGUAR E TYPE 4.2 SERIES 2**
Eleven hoses
081.347
£239.16 each | £199.30 ex VAT



**RADIATOR HOSE KIT
MINI COOPER 970/1071/1275**
Four hoses
081.330
£134.66 each | £112.22 ex VAT



**RADIATOR HOSE KIT-
MGB CHROME BUMPER 1971-74**
Five hoses
081.335
£109.06 each | £90.88 ex VAT



**RADIATOR HOSE KIT
MG MIDGET 1275 1966-1974**
Eight hoses from black silicone
081.339
£183.38 each | £152.82 ex VAT



**RADIATOR HOSE KIT
TRIUMPH STAG MK 2 1974-77**
Eight hoses
081.341
£155.69 each | £129.74 ex VAT



**RADIATOR HOSE KIT
TRIUMPH TR6 PI 1970-1976**
Seven hoses
081.343
£108.85 each | £90.71 ex VAT

LIGHTING
SWITCHES
IGNITION
WIRING

**HEATERS,
ELECTRIC
FANS**

FUEL AIR
GAUGES
WASHERS
WIPERS

MIRRORS
SEATS, SEAT
BELTS

STEERING
WHEELS

MOTORCYCLE
PARTS

ACCESSORIES

BODY
HARDWARE

CAR CARE
PAINT

OIL, GREASE

FITTINGS

WHEELS,
BRAKES

TOOLS

COMPETITION

CLOTHING

GIFTS

BOOKS

OTHER RADIATOR HOSE KITS (HAND CRAFTED FROM BLACK SILICONE)

Make	Model	Year	Part No.	Price each	Ex VAT
Austin Healey	Frogeye Sprite		081.351	£126.84	£105.70
MG	Midget 1500		081.344	£168.76	£140.63
MGB	Rubber Bumper	1974-89	081.336	£125.84	£104.87
Mini	850/998	1959-92	081.349	£155.09	£129.24
Morris	Minor 1000 (1098cc)		081.350	£155.09	£129.24
Triumph	Spitfire 1500		081.348	£137.59	£114.66
Triumph	Stag Mk I	1971-73	081.340	£207.96	£173.30
Triumph	TR6 MK 2		081.342	£169.00	£140.83

RADIATOR HOSES

+44(0) 1885 488 488

Hand crafted from black silicone



Straight Hose



Elbow 90°



Elbow 45°



Reducing Elbow 90



Straight Reducer



Superflex Hose



Alloy Joiner

LIGHTING
SWITCHES
IGNITION
WIRING

**HEATERS,
ELECTRIC
FANS**

FUEL AIR

GAUGES

WASHERS
WIPERS

MIRRORS

SEATS, SEAT
BELTS

STEERING
WHEELS

MOTORCYCLE
PARTS

ACCESSORIES

BODY
HARDWARE

CAR CARE
PAINT

OIL, GREASE

FITTINGS

WHEELS,
BRAKES

TOOLS

COMPETITION

CLOTHING

GIFTS

BOOKS

Description	Internal diameter mm	Part No.	Price each	Ex VAT
Straight Hose	16	081.360	£29.02	£24.18
Straight Hose	35	081.361	£43.61	£36.34
Elbow 90°	13	081.364	£12.26	£10.22
Elbow 90°	16	081.365	£12.26	£10.22
Elbow 90°	18	081.366	£13.31	£11.09
Elbow 90°	32	081.367	£16.68	£13.90
Elbow 45°	32	081.372	£18.61	£15.51
Elbow 45°	41	081.373	£21.20	£17.67
Straight Reducer	16-13	081.380	£10.46	£8.72
Straight Reducer	19-16	081.381	£10.51	£8.76
Straight Reducer	25-19	081.382	£11.12	£9.27
Straight Reducer	35-32	081.383	£14.20	£11.83
Straight Reducer	40-35	081.384	£16.84	£14.03
Reducing Elbow 90	16-13	081.387	£15.41	£12.84
Reducing Elbow 90	42-32	081.389	£20.46	£17.05
Superflex Hose	13	081.391	£40.04	£33.37
Superflex Hose	20	081.392	£45.48	£37.90
Superflex Hose	32	081.393	£54.76	£45.63
Superflex Hose	41	081.394	£64.48	£53.73
Alloy Joiner	13 External	081.400	£7.01	£5.84
Alloy Joiner	16 External	081.401	£7.01	£5.84
Alloy Joiner	19 External	081.402	£7.21	£6.01
Alloy Joiner	32 External	081.403	£9.47	£7.89
Alloy Joiner	35 External	081.404	£11.04	£9.20

RADIATOR CAPS

	RADIATOR CAPS			
	Stainless steel radiator caps which open under pressure listed below			
	p.s.i.	Part No.	Price each	Ex VAT
4	081.004	£11.52	£9.60	
7	081.007	£11.52	£9.60	
13	081.013	£11.52	£9.60	
20	081.020	£11.52	£9.60	

For your convenience we are listing here all of the hose clips we do:



STAINLESS STEEL HOSE CLIPS			
Automotive quality, corrosion resistant, worm drive			
Size	Part Nos.	Price each	Ex VAT
12-20mm	090.681	£0.95	£0.79
16-22mm	090.682	£0.97	£0.81
18-25mm	090.683	£1.01	£0.84
22-29mm	090.684	£1.20	£1.00
25-35mm	090.685	£1.27	£1.06
30-40mm	090.686	£1.28	£1.07
35-50mm	090.687	£1.39	£1.16
40-55mm	090.688	£1.46	£1.22
45-60mm	090.689	£1.60	£1.33
55-70mm	090.561	£1.68	£1.40
60-80mm	090.562	£1.80	£1.50
70-90mm	090.563	£1.84	£1.53
85-100mm	090.564	£2.00	£1.67
95-115mm	090.565	£2.26	£1.88
110-140mm	090.566	£2.39	£1.99
120-150mm	090.567	£2.59	£2.16
135-165mm	090.568	£2.68	£2.23
158-190mm	090.569	£2.68	£2.23



WIRE CLIPS			
SizeSiSS	Part Nos.	Price each	Ex VAT
Suits 1 3/4" hose	080.528	£2.44	£2.03
Single Wire for 3 3/4" hose	080.517	£3.16	£2.63
Single Wire for 4" hose	080.529	£3.16	£2.63
13-16mm	097.830	£1.50	£1.25
17-20mm	097.831	£1.50	£1.25
19-22mm	097.832	£1.50	£1.25
22-25mm	097.833	£1.50	£1.25
24-27mm	097.834	£1.68	£1.40
25-29mm	097.835	£1.56	£1.30
27-31mm	097.836	£1.56	£1.30
29-33mm	097.837	£1.56	£1.30
31-35mm	097.838	£1.56	£1.30
33-37mm	097.839	£1.56	£1.30
34-39mm	097.840	£1.62	£1.35
37-42mm	097.841	£1.74	£1.45
39-44mm	097.842	£1.80	£1.50
42-47mm	097.843	£1.80	£1.50
48-51mm	097.844	£1.80	£1.50
49-55mm	097.845	£1.80	£1.50
51-57mm	097.846	£1.80	£1.50
55-61mm	097.847	£1.98	£1.65
59-65mm	097.848	£2.10	£1.75
62-67mm	097.622	£2.10	£1.75
68-74mm	097.624	£2.40	£2.00
78-84mm	097.625	£3.00	£2.50
79-85mm	097.849	£3.10	£2.58

LIGHTING
SWITCHES
IGNITION
WIRING

**HEATERS,
ELECTRIC
FANS**

FUEL AIR
GAUGES
WASHERS
WIPERS
MIRRORS

SEATS, SEAT
BELTS

STEERING
WHEELS

MOTORCYCLE
PARTS

ACCESSORIES

BODY
HARDWARE

CAR CARE
PAINT

OIL, GREASE

FITTINGS

WHEELS,
BRAKES

TOOLS

COMPETITION

CLOTHING

GIFTS

BOOKS



BOX OF HOSE CLIPS

Zinc plated steel. Contains hose clips for hoses up to the following diameters: 8mm, 10mm, 12mm, 13mm, 14mm and 16mm

090.680

£35.94 each | £29.95 ex VAT



HOSE CLIPS

For fuel pipe or similar 7.8mm diameter. Design as shown. Sold as a packet of 10

090.633

£8.98 pkt 10 | £7.48 ex VAT



NUT & BOLT HOSE CLIPS			
Size	Part Nos.	Price each	Ex VAT
11-13mm	015.981	£1.14	£0.95
13-15mm	015.982	£1.14	£0.95
15-17mm	015.983	£1.14	£0.95
18-20mm	015.984	£1.14	£0.95



HOLDEN HOT SCREEN 12 VOLT SCREEN HEATER

12 volt adhesive Screen Heater. Fits to the inside of the rear window of your car and is wired in using the switch provided. Includes 1500 mm x 300 mm of central heater elements that you cut and fit to size on the two end connecting strips. Can also be fitted to your front screen. Particularly useful on rallies. Full fitting instructions included

080.109

£70.80 each | £59.00 ex VAT

LIGHTING
SWITCHES
IGNITION
WIRING

**HEATERS,
ELECTRIC
FANS**

HEATER HOSES (WATER)

FUEL AIR

GAUGES

WASHERS
WIPERS

MIRRORS

SEATS, SEAT
BELTS

STEERING
WHEELS

MOTORCYCLE
PARTS

ACCESSORIES

BODY
HARDWARE

CAR CARE
PAINT

OIL, GREASE

FITTINGS

WHEELS,
BRAKES

TOOLS

COMPETITION

CLOTHING

GIFTS

BOOKS



WATER HOSES

Top quality flexible water hose with smooth finish. Inside diameter $\frac{1}{2}$ " (12.7mm), outside diameter 19.5mm. Can be bent to a minimum radius of 88mm. Install using hose clips. Made to SAE J 20 R3 standard

080.538

£7.20 per metre | £6.00 ex VAT

As above with inside diameter $\frac{3}{8}$ " (16mm), outside diameter 23mm. Can be bent to a minimum radius of 112mm

080.539

£8.10 per metre | £6.75 ex VAT



STRAIGHT CONNECTOR

Copper, for $\frac{1}{2}$ " pipe

080.531

£5.38 each | £4.48 ex VAT

Copper, for $\frac{3}{8}$ " pipe

080.532

£2.92 each | £2.43 ex VAT



T PIECE

Copper, for $\frac{1}{2}$ "- $\frac{5}{8}$ "- $\frac{1}{2}$ " pipe

080.534

£11.64 each | £9.70 ex VAT

Copper, for $\frac{5}{8}$ "- $\frac{1}{2}$ "- $\frac{3}{8}$ " pipe

080.535

£5.77 each | £4.81 ex VAT



Y PIECE

Copper, for $\frac{3}{8}$ " pipe

080.536

£28.80 each | 24.00 ex VAT



LEFT HAND BLOWER
(Left) Blower for **Aston Martin** left hand model. 12 volt
080.559
£324.00 each | £270.00 ex VAT

BLOWER
(Right) Blower for **Austin Healey Sprite**. 12 volt
080.236
£280.80 each | £234.00 ex VAT



BLOWER
(Left) Blower for **Austin Healey 3000** etc. 12 volt
080.232
£324.00 each | £270.00 ex VAT

FOR HEATER HOSE TO FIT THESE BLOWERS REFER TO 080.518 BELOW

HEATER HOSES & NOZZLES



DEMIST HOSE
1 3/4" Plastic
080.520
£12.54 per metre | £10.45 ex VAT
1 3/4" Plastic
080.521
£9.30 per metre | £7.75 ex VAT



WIRE REINFORCED DEMIST HOSE
1 3/4" diameter
080.522
£12.00 per metre | £10.00 ex VAT
Wire Clip suits 1 3/4" hose
080.528
£2.44 each | £2.03 ex VAT



HEATER HOSES
3 3/4" (82.5mm) diameter. Fits Blowers on this page
080.518
£23.99 per metre | £19.99 ex VAT
Single Spiral Wire Clip suits 3 3/4" hose
080.517
£3.16 each | £2.63 ex VAT
4" (102mm) diameter wire reinforced heater hose
080.523
£27.46 per metre | £22.88 ex VAT
Single Spiral Wire Clip suits 4" hose
080.529
£3.16 each | £2.63 ex VAT



STRAIGHT NOZZLE
Metal, 235mm wide, uses 1 3/4" hose
080.524
£23.28 each | £19.40 ex VAT



SIDE ENTRY NOZZLE
Metal, 135mm wide uses 1 3/4" hose
080.526
£19.56 each | £16.30 ex VAT

LIGHTING
SWITCHES
IGNITION
WIRING

**HEATERS,
ELECTRIC
FANS**

FUEL AIR
GAUGES
WASHERS
WIPERS
MIRRORS

SEATS, SEAT
BELTS

STEERING
WHEELS

MOTORCYCLE
PARTS

ACCESSORIES

BODY
HARDWARE

CAR CARE
PAINT

OIL, GREASE

FITTINGS

WHEELS,
BRAKES

TOOLS

COMPETITION

CLOTHING

GIFTS

BOOKS

ELECTRIC RADIATOR FANS

+44(0) 1885 488 488



REVOTEC HIGH QUALITY, SLIMLINE ELECTRIC 12V FANS

A high quality electric radiator fan engineered by Revotec for vehicle applications. Waterproof to IP68, balanced blades, light weight, low noise (a special feature of this fan), finger guard and the bearings rated to run continuously

LIGHTING

SWITCHES

IGNITION

WIRING

HEATERS, ELECTRIC FANS

FUEL AIR

GAUGES

WASHERS

WIPERS

MIRRORS

SEATS, SEAT

BELTS

STEERING

WHEELS

MOTORCYCLE

PARTS

ACCESSORIES

BODY

HARDWARE

CAR CARE

PAINT

OIL, GREASE

FITTINGS

WHEELS, BRAKES

TOOLS

COMPETITION

CLOTHING

GIFTS

BOOKS

FOR MOUNTING IN FRONT OF RADIATOR (BLOWERS):

Fan Diameter	Depth	Air Flow cu m/hr	Current Draw amps	Weight kg	Voltage	Application/ for engine size up to	Part number	Price each	Price ex VAT
6"	59mm	450	6.9	1.1	12V	Oil cooler	081.500	£75.48	£62.90
7.5"	53mm	600	5.8	1.1	12V	Oil cooler	081.501	£77.42	£64.52
9"	53mm	1130	7.0	1.2	12V		081.502	£79.37	£66.14
10"	55mm	1520	7.1	1.2	12V	1700cc	081.503	£81.36	£67.80
11"	53mm	1650	7.7	1.2	12V		081.504	£85.32	£71.10
12"	56mm	1860	7.2	1.3	12V	4200cc	081.505	£87.12	£72.60

FOR MOUNTING BEHIND RADIATOR (SUCKERS):

Fan Diameter	Depth	Air Flow cu m/hr	Current Draw amps	Weight kg	Voltage	Application/ for engine size up to	Part number	Price each	Price ex VAT
6"	59mm	560	7.8	1.1	12V	Oil cooler	081.510	£75.48	£62.90
7.5"	53mm	700	5.9	1.1	12V	Oil cooler	081.511	£77.42	£64.52
9"	53mm	1180	7.6	1.2	12V		081.512	£79.37	£66.14
10"	55mm	1580	7.3	1.2	12V	1700cc	081.513	£81.36	£67.80
11"	53mm	1620	7.9	1.2	12V		081.514	£85.32	£71.10
12"	56mm	1890	7.1	1.3	12V	4200cc	081.515	£87.12	£72.60

UNIVERSAL MOUNTING BRACKETS

	<p>Made from laser cut aluminium to assist in fitting your Revotec fan to the radiator mountings/body of your car. Bend or cut it to suit your requirements. Supplied in pairs with everything to attach it to the fan housing. Leg length 200mm</p>			
	For Fan Diameter	Part number	Price each	Price ex VAT
	7.5"	081.525	£17.28	£14.40
	9"	081.526	£17.28	£14.40
	10"	081.527	£17.28	£14.40
	11"	081.528	£17.28	£14.40
	12"	081.529	£17.28	£14.40

THERMOSTATIC FAN CONTROL



An adjustable thermostatic fan control specially made to control all 12 volt fans. Made from billet aluminium, it fits into your radiator hose and is secured with two hose clips ensuring a perfect seal. Latest surface mount sensor with no mechanical parts to wear or fail. Simply adjusted with a screwdriver to bring in the radiator fan between 70 and 120°C. Supplied with 2 hose clamps, 30 amp relay, cap, 3 cable ties, 1 x self tapping screw and fitting instructions

For hose diameter	Part No.	Price each	Price ex VAT
28mm Negative Earth	080.870	£71.94	£59.95
32mm Negative Earth	080.871	£71.94	£59.95
35mm Negative Earth	080.872	£71.94	£59.95
38mm Negative Earth	080.873	£71.94	£59.95
28mm Positive Earth	081.541	£107.94	£89.95
32mm Positive Earth	081.542	£107.94	£89.95
35mm Positive Earth	081.543	£107.94	£89.95
38mm Positive Earth	081.544	£107.94	£89.95



INSTALLATION KIT

If you are fitting your Revotec fan direct to the radiator, either in front or behind, this is the fitting kit you will need. Comprises 4 pull through pins, 4 foam pads, 4 rubber washers and 4 buttons. It also enables you to transfer your electric fan from one car to another

081.520
£7.14 each | £5.95 ex VAT



INSTALLATION KIT

This kit is similar to 081.520 but with the addition of a relay. Comprises 4 pull through pins, 4 foam pads, 4 rubber washers, buttons, relay, loom and crimps. It also enables you to transfer your electric fan from one car to another

081.521
£17.94 each | £14.95 ex VAT



VERRIDE SWITCH

3 Way rotary switch for use with a Revotec Fan Control enabling the fan to be manually controlled from inside the car either On, Off or Automatic. Supplied with: black anodised mounting bracket kit. Sealed 3 metre wiring loom and connection diagram

081.522
£35.99 each | £29.99 ex VAT

More Radiator Fans on following pages

LIGHTING
SWITCHES
IGNITION
WIRING

**HEATERS,
ELECTRIC
FANS**

FUEL AIR
GAUGES
WASHERS
WIPERS
MIRRORS

SEATS, SEAT
BELTS
STEERING
WHEELS

MOTORCYCLE
PARTS
ACCESSORIES

BODY
HARDWARE

CAR CARE
PAINT

OIL, GREASE

FITTINGS

WHEELS,
BRAKES

TOOLS

COMPETITION

CLOTHING

GIFTS

BOOKS

RADIATOR FAN KITS

+44(0) 1885 488 488

LIGHTING
SWITCHES
IGNITION
WIRING

**HEATERS,
ELECTRIC
FANS**

FUEL AIR

GAUGES

WASHERS
WIPERS

MIRRORS

SEATS, SEAT
BELTS

STEERING
WHEELS

MOTORCYCLE
PARTS

ACCESSORIES

BODY
HARDWARE

CAR CARE
PAINT

OIL, GREASE

FITTINGS

WHEELS,
BRAKES

TOOLS

COMPETITION

CLOTHING

GIFTS

BOOKS



Specifically engineered to fit and cool your classic car perfectly. Supplied complete with quality electric fan and all necessary brackets, fixings, hose clips and connectors to provide a complete installation on your car. They fit without any permanent modifications except for the need to cut radiator hoses to fit the electronic temperature controller. Fits with basic hand tools. OEM components used throughout. The latest fan and controller technology are used together for the ultimate cooling package. For 12 volt negative earth only

RADIATOR FAN KITS

<i>Make</i>	<i>Model</i>	<i>Part No.</i>	<i>Price each</i>	<i>Price ex VAT</i>
Jaguar	E Type Series 1	081.300	£239.94	£199.95
MG	MGA	081.301	£191.94	£159.95
MG	MGB 1962-76 (Chrome Bumper)	081.302	£191.94	£159.95
MG	MGB 1976-80 (Rubber Bumper)	081.304	£191.94	£159.95
MG	MGB V8	081.305	£278.34	£231.95
MG/Austin Healey	Midget/Sprite Vertical Flow Radiator	081.306	£191.94	£159.95
MG/Austin Healey	Midget/Sprite 1275cc Cross Flow Radiator	081.307	£191.94	£159.95
MG	Midget 1500cc	081.308	£191.94	£159.95
Mini	Classic Mini (Side Mounted Radiator)	081.309	£191.94	£159.95
Morris	Minor	081.310	£191.94	£159.95
Triumph	GT6	081.311	£191.94	£159.95
Triumph	Herald	081.312	£191.94	£159.95
Triumph	Stag	081.313	£203.94	£169.95
Triumph	Spitfire (Wide Radiator Only)	081.314	£191.94	£159.95
Triumph	TR2, TR3 and TR4	081.315	£191.94	£159.95
Triumph	TR4A	081.316	£191.94	£159.95
Triumph	TR5 and TR6 (shown above)	081.317	£191.94	£159.95



081.300



081.301

SLIMLINE ELECTRIC FANS

	A series of 12V slimline electric fans for fitting to the front (blowers) or to the rear (suckers) of your radiator to provide cooling. Supplied with a variety of adaptors and instructions to enable you to fit the fan to your car. (A switch or thermostatic control are not included). For 12 volt negative earth only. Made in China			
	Size	Part No.	Price each	Price ex VAT
	9" Blower for engines up to 1200cc	080.900	£69.70	£58.08
	10" Blower for engines up to 2000cc	080.901	£72.47	£60.39
	12" Blower for engines over 2000cc	080.902	£75.28	£62.73
	9" Sucker for engines up to 1200cc	080.905	£69.70	£58.08
	10" Sucker for engines up to 2000cc	080.906	£72.47	£60.39
	12" Sucker for engines over 2000cc	080.907	£75.28	£62.73



FITTING KIT

(Left) Comprises 4 pull throughs and fixings, also a selection of mounting brackets. Apart from providing spares, this Kit enables you to transfer your electric fan from one car to another

080.908
£14.40 each | £12.00 ex VAT



THERMOSTATIC SWITCH

(Right) This switch is for mounting near the top hose and allows you to set the temperature at which the fan comes on. It includes a probe which you fit inside the end of the top hose

080.909
£38.40 each | £32.00 ex VAT

ELECTRIC WATER PUMPS

ELECTRIC WATER PUMP 80 LITRES PER MINUTE

(Right) A new concept in water pumps for pumping cooling water around your engine. Suitable for normally aspirated engines up to 5 litres. It is supplied here in kit form to replace your existing belt driven water pump. You can just switch it on and off when required or use an adjustable electronic controller which supplies the exact voltage to govern water pump speed to achieve desired cooling requirements (Supplied separately refer to 080.781). The pump may be fitted in any location where it can be connected into the bottom hose. Adapters are supplied in this kit to suit various hose diameters. The existing pump can be left in place - instructions for this are provided with the kit. 2 years manufacturer's warranty

080.780
£198.14 each | £165.12 ex VAT



ELECTRIC WATER PUMP CONTROLLER

(Left) This electronic controller is designed to be used with water pump 080.780 and mounted under the dashboard where the adjustments can be reached. It can be set to switch the pump on at 75, 80, 85, 90 or 95 deg C. The temperature sensor can either be inserted into the existing thermostat housing for which an 11mm drill and ¼ BSP tap are needed, or fitted into the top hose for which adaptors are provided. Either way the existing thermostat is removed. If you wire it to the battery side of the ignition switch it will allow the pump to run on after the engine has been switched off to cool it down after a run. Comprehensive instructions, wiring diagrams, wiring and connectors are all supplied

080.781
£197.53 each | £164.61 ex VAT



ELECTRIC WATER PUMP 115 LITRES PER MINUTE

(Right) Suitable for engines over 5 litres and modified engines. It is supplied here in kit form, complete with adjustable electronic controller, to replace your existing belt driven water pump. The controller can be set to switch the pump on at 75, 80, 85, 90 or 95 deg C. The pump may be fitted in any location where it can be connected into the bottom hose. Adapters are supplied in this kit to suit various hose diameters. The existing pump can be left in place - instructions for this are provided with the kit. 2 years manufacturer's warranty

080.782
£416.16 each | £346.80 ex VAT



LIGHTING
SWITCHES
IGNITION
WIRING

HEATERS,
ELECTRIC
FANS

FUEL AIR
GAUGES
WASHERS
WIPERS
MIRRORS
SEATS, SEAT
BELTS
STEERING
WHEELS

MOTORCYCLE
PARTS

ACCESSORIES

BODY
HARDWARE

CAR CARE
PAINT

OIL, GREASE

FITTINGS

WHEELS,
BRAKES

TOOLS

COMPETITION

CLOTHING

GIFTS

BOOKS